

## Buffered H-Bridge

### DESCRIPTION

The Si9986 is an integrated, buffered H-bridge with TTL compatible inputs and the capability of delivering a continuous 1.0 A at  $V_{DD} = 12\text{ V}$  (room temperature) at switching rates up to 200 kHz. Internal logic prevents the upper and lower outputs of either half-bridge from being turned on simultaneously. Unique input codes allow both outputs to be forced low (for braking) or forced to a high impedance level.

The Si9986 is available in both standard and lead (Pb)-free, 8-pin SOIC packages, specified to operate over a voltage range of 3.8 V to 13.2 V, and the commercial temperature range of 0 to 70 °C (C suffix) and the industrial temperature range of - 40 to 85 °C (D suffix).

### FEATURES

- 1.0 A H-Bridge
- 200 kHz Switching Rate
- Shoot-Through Limited
- TTL Compatible Inputs
- 3.8 to 13.2 V Operating Range
- Surface Mount Packaging



**RoHS\***  
COMPLIANT

### APPLICATIONS

- VCM Driver
- Brushed Motor Driver
- Stepper Motor Driver
- Power Converter
- Optical Disk Drives
- Power Supplies
- High Performance Servo

### FUNCTIONAL BLOCK DIAGRAM, PIN CONFIGURATION AND TRUTH TABLE

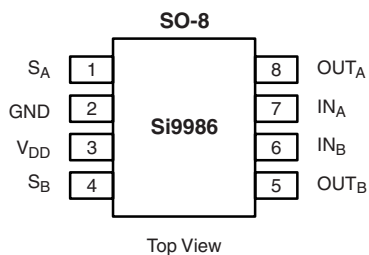

TRUTH TABLE			
IN <sub>A</sub>	IN <sub>B</sub>	OUT <sub>A</sub>	OUT <sub>B</sub>
1	0	1	0
0	1	0	1
0	0	0	0
1	1	HiZ	HiZ

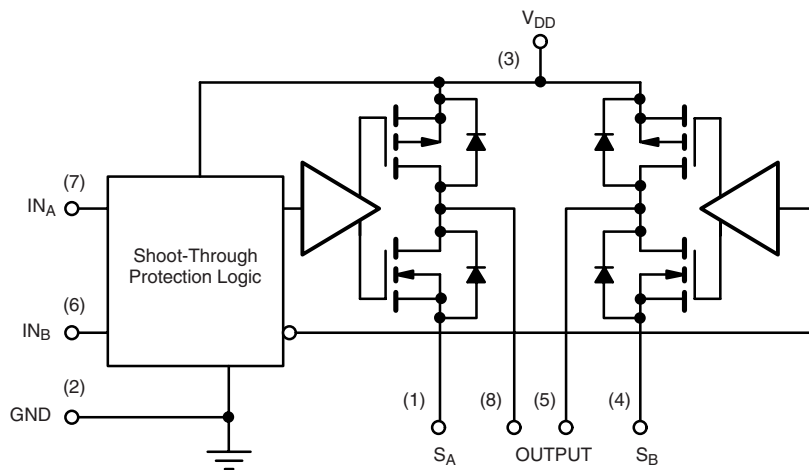

PIN DESCRIPTION		
Pin Number	Name	Function
1	S <sub>A</sub>	Source of the low-side MOSFET on bridge arm A
2	GND	Ground
3	V <sub>DD</sub>	IC power supply
4	S <sub>B</sub>	Source of the low-side MOSFET on bridge arm B
5	OUT <sub>B</sub>	Center tap of bridge arm B. Connects to one end of the load
6	IN <sub>B</sub>	Input signal to control bridge arm B
7	IN <sub>A</sub>	Input signal to control bridge arm A
8	OUT <sub>A</sub>	Center tap of bridge arm A. Connects to the other end of the load

ORDERING INFORMATION		
Part Number	Temperature Range	Package
Si9986CY-T1	0 to 70 °C	Tape and Reel
Si9986DY-T1	- 40 to 85 °C	
Si9986CY-T1-E3	0 to 70 °C	Lead (Pb)-free Tape and Reel
Si9986DY-T1-E3	- 40 to 85 °C	
Si9986CY	0 to 70 °C	Bulk (tubes)
Si9986DY	- 40 to 85 °C	

\* Pb containing terminations are not RoHS compliant, exemptions may apply.

<b>ABSOLUTE MAXIMUM RATINGS<sup>a</sup></b>			
Parameter		Limit	Unit
Voltage on any Pin with Respect to Ground		- 0.3 to $V_{DD} + 0.3$	V
Voltage on Pins 5, 8 with Respect to GND		- 1 to $V_{DD} + 1$	
Voltage on Pins 1, 4		- 0.3 to $GND + 1$	
Peak Output Current		1.5	A
Storage Temperature		- 65 to 150	°C
Maximum Junction Temperature ( $T_J$ )		150	
Maximum $V_{DD}$		15	V
Power Dissipation <sup>b</sup>		1	W
$\Theta_{JA}$		100	°C/W
Operating Temperature Range		Si9986CY	0 to 70
		Si9986DY	- 45 to 85

## Notes:

- a. Device Mounted with all leads soldered or welded to PC board.  
 b. Derate 10 mW/°C above 25 °C.

Stresses beyond those listed under "Absolute Maximum Ratings" may cause permanent damage to the device. These are stress ratings only, and functional operation of the device at these or any other conditions beyond those indicated in the operational sections of the specifications is not implied. Exposure to absolute maximum rating conditions for extended periods may affect device reliability.

<b>RECOMMENDED OPERATING RANGE</b>		
Parameter	Limit	Unit
$V_{DD}$	3.8 to 13.2	V
Maximum Junction Temperature ( $T_J$ )	125	°C

<b>SPECIFICATIONS</b>						
Parameter	Symbol	Test Conditions Unless Otherwise Specified $V_{DD} = 3.8$ to $13.2$ V $S_A$ at GND, $S_B$ at GND	Limits C Suffix, 0 to 70 °C D Suffix, - 40 to 85 °C			Unit
			Min <sup>a</sup>	Typ <sup>b</sup>	Max <sup>a</sup>	
<b>Input</b>						
Input Voltage High	$V_{INH}$		2			V
Input Voltage Low	$V_{INL}$				1	
Input Current with Input Voltage High	$I_{INH}$	$V_{IN} = 2$ V			1	µA
Input Current with Input Voltage Low	$I_{INL}$	$V_{IN} = 0$ V	- 1			
<b>Output</b>						
Output Voltage High	$V_{OUTH}$	$I_{OUT} = - 500$ mA	$V_{DD} = 10.8$ V	10.5	10.7	V
			$V_{DD} = 4.5$ V	4.1	4.3	
		$I_{OUT} = - 300$ mA, $V_{DD} = 3.8$ V		3.4	3.7	
Output Voltage Low	$V_{OUTL}$	$I_{OUT} = 500$ mA	$V_{DD} = 10.8$ V		0.2	
			$V_{DD} = 4.5$ V		0.2	0.4
		$I_{OUT} = 300$ mA, $V_{DD} = 3.8$ V			0.1	0.4
Output Leakage Current High	$I_{OLH}$	$I_{NA} = I_{NB} \geq 2$ V, $V_{OUT} = V_{DD} = 13.2$ V	- 10	0		µA
Output Leakage Current Low	$I_{OLL}$	$V_{OUT} = 0$ , $V_{DD} = 13.2$ V		0	10	
Output V Clamp High	$V_{CLH}$	$I_{NA} = I_{NB} \geq 2$ V	$I_{OUT} = 100$ mA		$V_{DD} + 0.7$	V
Output V Clamp Low	$V_{CLL}$		$I_{OUT} = - 100$ mA		- 0.7	
<b>Supply</b>						
$V_{DD}$ Supply Current	$I_{DD}$	$I_N = 100$ kHz, $V_{DD} = 5$ V		2		mA
		$I_{NA} = I_{NB} = 4.5$ V, $V_{DD} = 5.5$ V			300	µA
<b>Dynamic</b>						
Propogation Delay Time	$T_{PLH}$	$V_{DD} = 5$ V		300		nS
	$T_{PHL}$			100		

## Notes:

- a. The algebraic convention whereby the most negative value is a minimum and the most positive a maximum, is used in this data sheet.  
 b. Typical values are for DESIGN AID ONLY, not guaranteed nor subject to production testing.

**TYPICAL CHARACTERISTICS** 25 °C, unless otherwise noted

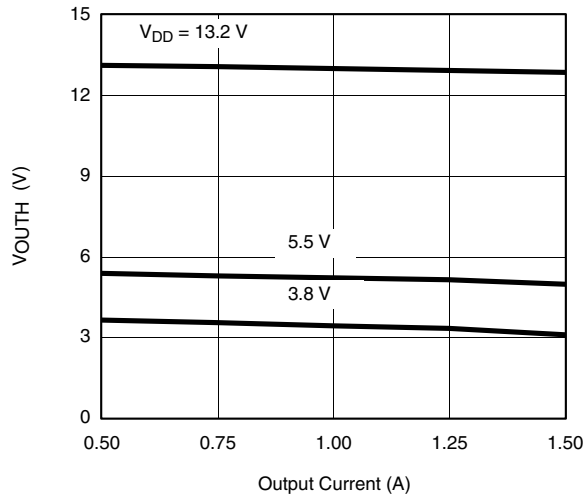

**Output High Voltage vs. Output Current**

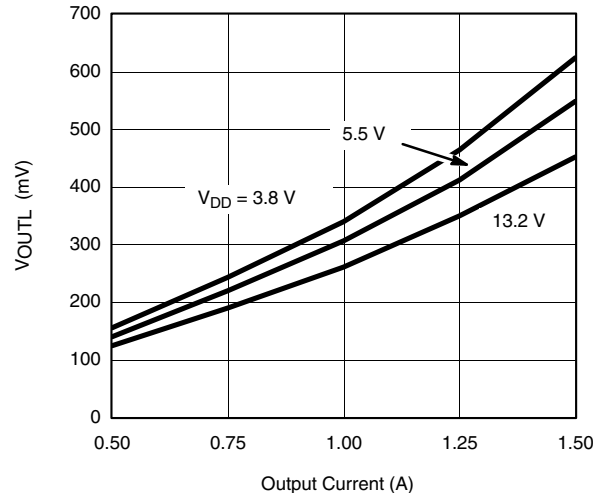

**Output Low Voltage vs. Output Current**

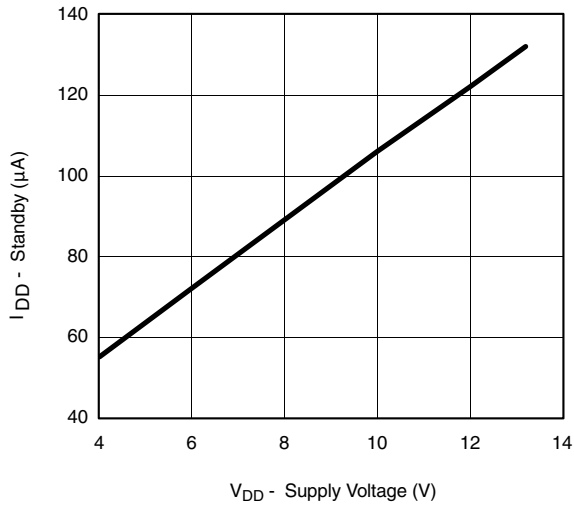

**Supply Current vs. Supply Voltage**

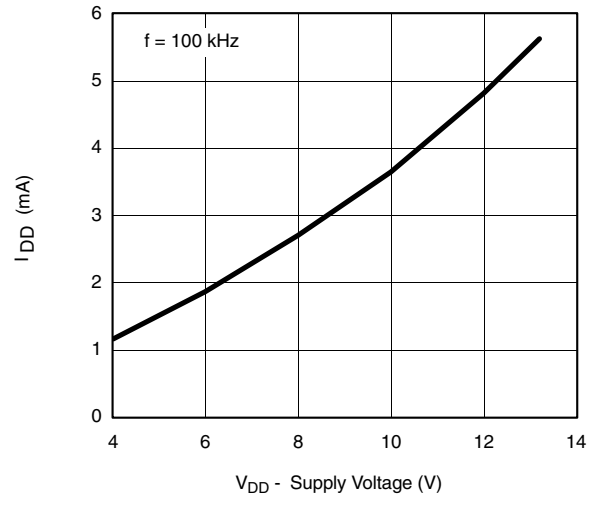

**Supply Current vs. Supply Voltage**

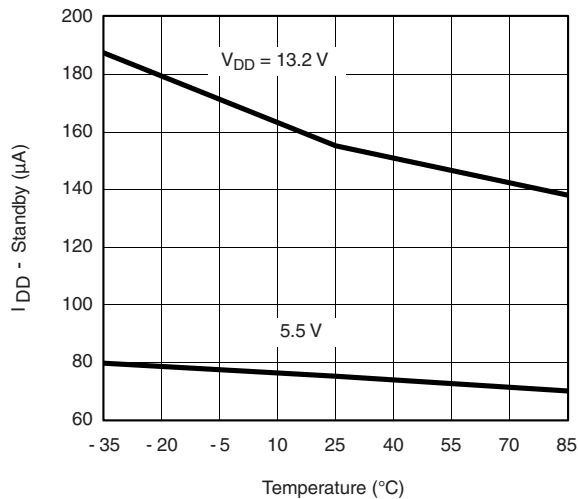

**Supply Current vs. Temperature**

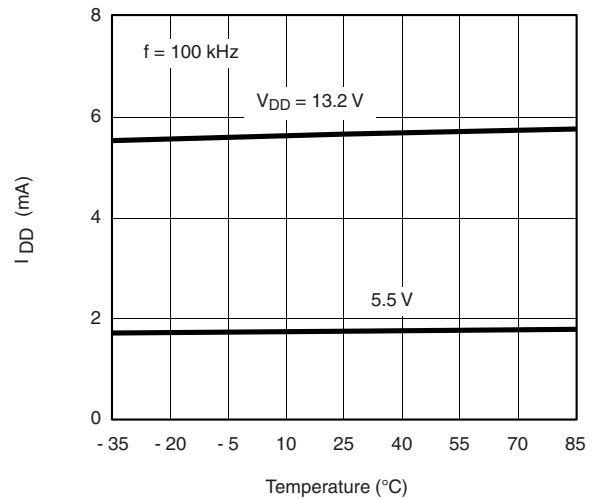

**Supply Current vs. Temperature**

**TYPICAL CHARACTERISTICS** 25 °C, unless otherwise noted

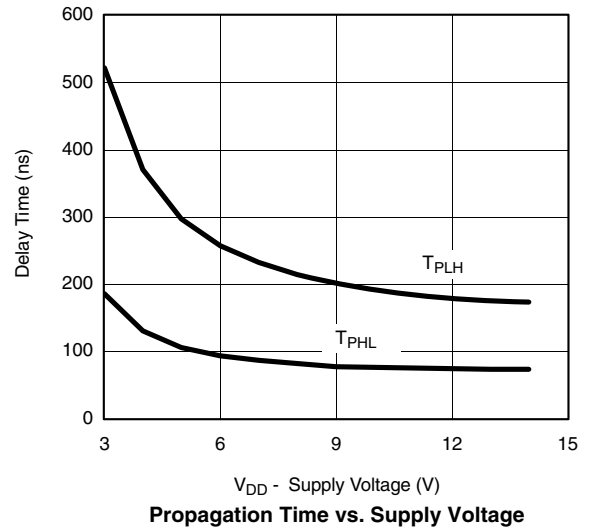
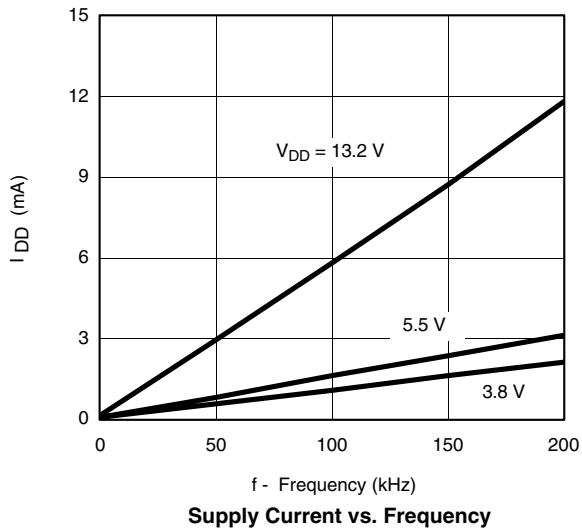

Vishay Siliconix maintains worldwide manufacturing capability. Products may be manufactured at one of several qualified locations. Reliability data for Silicon Technology and Package Reliability represent a composite of all qualified locations. For related documents such as package/tape drawings, part marking, and reliability data, see <http://www.vishay.com/ppg?70007>.

## SOIC (NARROW): 8-LEAD

JEDEC Part Number: MS-012



DIM	MILLIMETERS		INCHES	
	Min	Max	Min	Max
A	1.35	1.75	0.053	0.069
A <sub>1</sub>	0.10	0.20	0.004	0.008
B	0.35	0.51	0.014	0.020
C	0.19	0.25	0.0075	0.010
D	4.80	5.00	0.189	0.196
E	3.80	4.00	0.150	0.157
e	1.27 BSC		0.050 BSC	
H	5.80	6.20	0.228	0.244
h	0.25	0.50	0.010	0.020
L	0.50	0.93	0.020	0.037
q	0°	8°	0°	8°
S	0.44	0.64	0.018	0.026
ECN: C-06527-Rev. I, 11-Sep-06				
DWG: 5498				



## Disclaimer

ALL PRODUCT, PRODUCT SPECIFICATIONS AND DATA ARE SUBJECT TO CHANGE WITHOUT NOTICE TO IMPROVE RELIABILITY, FUNCTION OR DESIGN OR OTHERWISE.

Vishay Intertechnology, Inc., its affiliates, agents, and employees, and all persons acting on its or their behalf (collectively, "Vishay"), disclaim any and all liability for any errors, inaccuracies or incompleteness contained in any datasheet or in any other disclosure relating to any product.

Vishay makes no warranty, representation or guarantee regarding the suitability of the products for any particular purpose or the continuing production of any product. To the maximum extent permitted by applicable law, Vishay disclaims (i) any and all liability arising out of the application or use of any product, (ii) any and all liability, including without limitation special, consequential or incidental damages, and (iii) any and all implied warranties, including warranties of fitness for particular purpose, non-infringement and merchantability.

Statements regarding the suitability of products for certain types of applications are based on Vishay's knowledge of typical requirements that are often placed on Vishay products in generic applications. Such statements are not binding statements about the suitability of products for a particular application. It is the customer's responsibility to validate that a particular product with the properties described in the product specification is suitable for use in a particular application. Parameters provided in datasheets and/or specifications may vary in different applications and performance may vary over time. All operating parameters, including typical parameters, must be validated for each customer application by the customer's technical experts. Product specifications do not expand or otherwise modify Vishay's terms and conditions of purchase, including but not limited to the warranty expressed therein.

Except as expressly indicated in writing, Vishay products are not designed for use in medical, life-saving, or life-sustaining applications or for any other application in which the failure of the Vishay product could result in personal injury or death. Customers using or selling Vishay products not expressly indicated for use in such applications do so at their own risk and agree to fully indemnify and hold Vishay and its distributors harmless from and against any and all claims, liabilities, expenses and damages arising or resulting in connection with such use or sale, including attorneys fees, even if such claim alleges that Vishay or its distributor was negligent regarding the design or manufacture of the part. Please contact authorized Vishay personnel to obtain written terms and conditions regarding products designed for such applications.

No license, express or implied, by estoppel or otherwise, to any intellectual property rights is granted by this document or by any conduct of Vishay. Product names and markings noted herein may be trademarks of their respective owners.

## Material Category Policy

**Vishay Intertechnology, Inc. hereby certifies that all its products that are identified as RoHS-Compliant fulfill the definitions and restrictions defined under Directive 2011/65/EU of The European Parliament and of the Council of June 8, 2011 on the restriction of the use of certain hazardous substances in electrical and electronic equipment (EEE) - recast, unless otherwise specified as non-compliant.**

**Please note that some Vishay documentation may still make reference to RoHS Directive 2002/95/EC. We confirm that all the products identified as being compliant to Directive 2002/95/EC conform to Directive 2011/65/EU.**